

INVERTEC® 170TX 170TPX & 220TPX

OPERATOR'S MANUAL



ENGLISH



Lincoln Electric Bester Sp. z o.o.
ul. Jana III Sobieskiego 19A, 58-260 Bielawa, Poland
www.lincolnelectric.eu



THANKS! For having chosen the QUALITY of the Lincoln Electric products.

- Please Examine Package and Equipment for Damage. Claims for material damaged in shipment must be notified immediately to the dealer.
- For future reference record in the table below your equipment identification information. Model Name, Code & Serial Number can be found on the machine rating plate.

Model Name:	
.....	
Code & Serial number:	
.....
Date & Where Purchased:	
.....

ENGLISH INDEX

Technical Specifications (170TX/TPX) CE model	1
Technical Specifications (170TPX) AUS model	2
Technical Specifications (220TPX) CE model.....	3
Technical Specifications (220TPX) AUS model	4
ECO design information	5
Electromagnetic Compatibility (EMC) for 170TX/TPX	7
Electromagnetic Compatibility (EMC) for 220TPX.....	8
Safety	9
Installation and Operator Instructions.....	11
WEEE	24
Spare Parts	24
REACH	24
Authorized Service Shops Location	24
Electrical Schematic.....	24
Suggested Accessories.....	25

Technical Specifications (170TX/TPX) CE model

NAME		INDEX	
INVERTEC® 170TX CE		K12054-1	
INVERTEC® 170TPX CE		K12055-1	
INPUT			
Input Voltage U_1		EMC Class	Frequency
230Vac \pm 15%		A	50/60 Hz
Input Line	Input Power at Rated Cycle	Input Amperes I_{1max}	$\cos\phi$
230Vac	100% (Stick)	3.2KW	30% Stick 37A 30% Stick 0.6
	100% (TIG)	2.5KW	
	30% (Stick)	5.1KW	
	35% (TIG)	3.7KW	
RATED OUTPUT			
Input Line	Duty Cycle 40°C (based on a 10 min. period)	Output Current I_2	Output Voltage U_2
230Vac	100% (Stick)	110A	24.4V
	100% (TIG)	130A	15.2V
	30% (Stick)	160A	26.4V
	35% (TIG)	170A	16.8V
OUTPUT RANGE			
Welding Current Range		Open Circuit Voltage OCV U_0	
5 – 170A		63 Vdc	
RECOMMENDED INPUT CABLE AND FUSE SIZES			
Fuse (time delayed) or Circuit Breaker Size		Input Power Cable	
16A		3x2.5mm ²	
DIMENSIONS AND WEIGHT			
Height	Width	Length	Net Weight
328 mm	212 mm	456 mm	12 Kg
Operating Temperature	Storage Temperature	Operating Humidity (t=20°C)	Protection Degree
-10°C to +40°C	-25°C to 55°C	Not Applicable	IP23

Technical Specifications (170TPX) AUS model

NAME			INDEX	
INVERTEC® 170TPX AUS			K12055-2	
INPUT				
Input Voltage U ₁			EMC Class	Frequency
230Vac ± 15%			A	50/60 Hz
Input Line	Input Power at Rated Cycle		Input Amperes I _{1max}	cosφ
230Vac	100% (Stick)	3.2KW	30% Stick 37 A	30% Stick 0.6
	100% (TIG)	2.5KW		
	30% (Stick)	5.1KW		
	30% (TIG)	3.7KW		
240Vac (15A circuit braker)	100% (Stick)	2 kW	25% Stick 37 A	30% Stick 0.6
	100% (TIG)	1.9 kW		
	15% (Stick)	5.2 kW		
	25% (TIG)	3.8 kW		
RATED OUTPUT				
Input Line	Duty Cycle 40°C (based on a 10 min. period)		Output Current I ₂	Output Voltage U ₂
230Vac	100% (Stick)		110A	24.4 V
	100% (TIG)		130A	15.2 V
	30% (Stick)		160A	26.4 V
	30% (TIG)		170A	16.8 V
240Vac (15A circuit braker)	100% (Stick)		75 A	23 V
	100% (TIG)		100 A	14 V
	15% (Stick)		160 A	24.4 V
	25% (TIG)		170 A	16.8 V
OUTPUT RANGE				
Welding Current Range			Open Circuit Voltage OCV U ₀	
5 – 170A			6.5 Vdc	
RECOMMENDED INPUT CABLE AND FUSE SIZES				
Fuse (time delayed) or Circuit Breaker Size			Input Power Cable	
15A			3x2.5mm ²	
DIMENSIONS AND WEIGHT				
Height	Width	Length	Net Weight	
328 mm	212 mm	456 mm	12 Kg	
Operating Temperature	Storage Temperature	Operating Humidity (t=20°C)	Protection Degree	
-10°C to +40°C	-25°C to 55°C	Not Applicable	IP23	

Technical Specifications (220TPX) CE model

NAME		INDEX	
INVERTEC® 220TPX CE		K12057-1	
INPUT			
Input Voltage U ₁		EMC Class	Frequency
115 - 230Vac ± 15%		A	50/60 Hz
Input Line	Input Power at Rated Cycle	Input Amperes I _{1max}	cosφ
115Vac	100% (Stick)	2.5 kW	30,8 A
	100% (TIG)	2.1 kW	
	35% (Stick)	3.3 kW	
	25% (TIG)	3.4 kW	
	60% (Stick)	2.9 kW	
	60% (TIG)	2.2 kW	
230Vac	100% (Stick)	3.9 kW	24.2 A
	100% (TIG)	3.0 kW	
	35% (Stick)	5.5 kW	
	25% (TIG)	5.3 kW	
	60% (Stick)	4.3 kW	
	60% (TIG)	3.6 kW	
RATED OUTPUT			
Input Line	Duty Cycle 40°C (based on a 10 min. period)	Output Current I ₂	Output Voltage U ₂
230 Vac	100% (Stick)	130 A	25.2 V
	100% (TIG)	150 A	16.0 V
	60% (Stick)	140 A	25.6 V
	60% (TIG)	170 A	16.8 V
	35% (Stick)	170 A	26.8 V
	25% (TIG)	220 A	18.8 V
115 Vac	100% (Stick)	90 A	23.6 V
	100% (TIG)	110 A	14.4 V
	60% (Stick)	100 A	24 V
	60% (TIG)	120 A	14.8 V
	35% (Stick)	110 A	24.4 V
	25% (TIG)	160 A	16.4 V
OUTPUT RANGE			
Welding Current Range		Open Circuit Voltage OCV U ₀	
5 A – 170 A STICK		57 Vdc	
2 A – 220 A - TIG			
RECOMMENDED INPUT CABLE AND FUSE SIZES			
Fuse (time delayed) or Circuit Breaker Size		Input Power Cable	
20 A		3x2.5mm ²	
DIMENSIONS AND WEIGHT			
Height	Width	Length	Net Weight
328 mm	212 mm	456 mm	12 Kg
Operating Temperature	Storage Temperature	Operating Humidity (t=20°C)	Protection Degree
-10°C to +40°C	-25°C to 55°C	Not Applicable	IP23

Technical Specifications (220TPX) AUS model

NAME		INDEX	
INVERTEC® 220TPX AUS		K12057-2	
INPUT			
Input Voltage U_1		EMC Class	Frequency
240Vac \pm 15%		A	50/60 Hz
Input Line	Input Power at Rated Cycle	Input Amperes I_{1max}	$\cos\phi$
240 Vac	100% (Stick)	3.9 kW	24.2 A
	100% (TIG)	3.0 kW	
	35% (Stick)	5.5 kW	
	25% (TIG)	5.3 kW	
	60% (Stick)	4.3 kW	
	60% (TIG)	3.6 kW	
0.97			
RATED OUTPUT			
Input Line	Duty Cycle 40°C (based on a 10 min. period)	Output Current I_2	Output Voltage U_2
240 Vac	100% (Stick)	130 A	25.2 V
	100% (TIG)	150 A	16.0 V
	60% (Stick)	140 A	25.6 V
	60% (TIG)	170 A	16.8 V
	35% (Stick)	170 A	26.8 V
	25% (TIG)	220 A	18.8 V
OUTPUT RANGE			
Welding Current Range		Open Circuit Voltage OCV U_0	
5 A – 170 A STICK		6.5 Vdc	
2 A – 220 A - TIG			
RECOMMENDED INPUT CABLE AND FUSE SIZES			
Fuse (time delayed) or Circuit Breaker Size		Input Power Cable	
15 A		3x2.5mm ²	
DIMENSIONS AND WEIGHT			
Height	Width	Length	Net Weight
328 mm	212 mm	456 mm	12 Kg
Operating Temperature	Storage Temperature	Operating Humidity (t=20°C)	Protection Degree
-10°C to +40°C	-25°C to 55°C	Not Applicable	IP23

ECO design information

The equipment has been designed in order to be compliant with the Directive 2009/125/EC and the Regulation 2019/1784/EU.

Efficiency and idle power consumption:

Index	Name	Efficiency when max power consumption / Idle power consumption	Equivalent model
K12054-1	INVERTEC® 170TX CE	82,6 % / 32W	No equivalent model
K12055-1	INVERTEC® 170TPX CE	82,6 % / 32W	No equivalent model
K12055-2	INVERTEC® 170TPX AUS	82,6 % / 32W	No equivalent model
K12057-1	INVERTEC® 220TPX CE	82,8 % / 30W	No equivalent model
K12057-2	INVERTEC® 220TPX AUS	82,8 % / 30W	No equivalent model

Idle state occurs under the condition specified in below table

IDLE STATE	
Condition	Presence
MIG mode	
TIG mode	X
STICK mode	
After 30 minutes of non-working	
Fan off	X

The value of efficiency and consumption in idle state have been measured by method and conditions defined in the product standard EN 60974-1:20XX.

Manufacturer's name, product name, code number, product number, serial number and date of production can be read from rating plate.

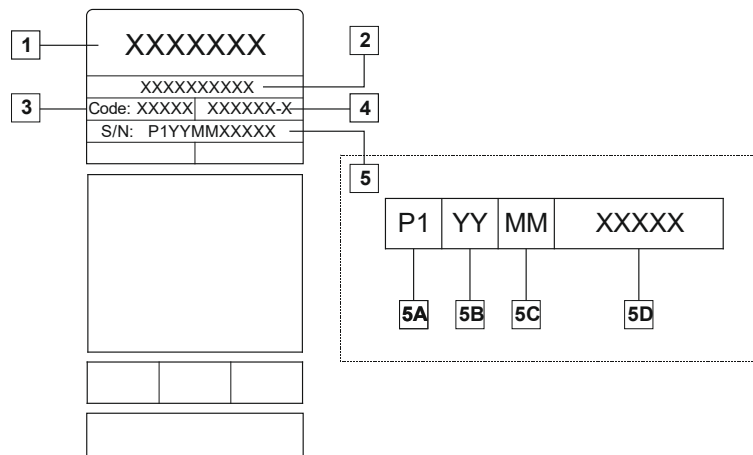

Where:

- 1- Manufacturer name and address
- 2- Product name
- 3- Code number
- 4- Product number
- 5- Serial number
 - 5A- country of production
 - 5B- year of production
 - 5C- month of production
 - 5D- progressive number different for each machine

Typical gas usage for **MIG/MAG** equipment:

Material type	Wire diameter [mm]	DC electrode positive		Wire Feeding [m/min]	Shielding Gas	Gas flow [l/min]
		Current [A]	Voltage [V]			
Carbon, low alloy steel	0,9 ÷ 1,1	95 ÷ 200	18 ÷ 22	3,5 – 6,5	Ar 75%, CO ₂ 25%	12
Aluminium	0,8 ÷ 1,6	90 ÷ 240	18 ÷ 26	5,5 – 9,5	Argon	14 ÷ 19
Austenic stainless steel	0,8 ÷ 1,6	85 ÷ 300	21 ÷ 28	3 - 7	Ar 98%, O ₂ 2% / He 90%, Ar 7,5% CO ₂ 2,5%	14 ÷ 16
Copper alloy	0,9 ÷ 1,6	175 ÷ 385	23 ÷ 26	6 - 11	Argon	12 ÷ 16
Magnesium	1,6 ÷ 2,4	70 ÷ 335	16 ÷ 26	4 - 15	Argon	24 ÷ 28

Tig Process:

In TIG welding process, gas usage depends on cross-sectional area of the nozzle. For commonly used torches:

Helium: 14-24 l/min
 Argon: 7-16 l/min

Notice: Excessive flow rates causes turbulence in the gas stream which may aspirate atmospheric contamination into the welding pool.

Notice: A cross wind or draft moving can disrupt the shielding gas coverage, in the interest of saving of protective gas use screen to block air flow.



End of life

At end of life of product, it has to be disposal for recycling in accordance with Directive 2012/19/EU (WEEE), information about the dismantling of product and Critical Raw Material (CRM) present in the product, can be found at <https://www.lincolnelectric.com/en-gb/support/Pages/operator-manuals-eu.aspx>

Electromagnetic Compatibility (EMC) for 170TX/TPX

01/11

This machine has been designed in accordance with all relevant directives and standards. However, it may still generate electromagnetic disturbances that can affect other systems like telecommunications (telephone, radio, and television) or other safety systems. These disturbances can cause safety problems in the affected systems. Read and understand this section to eliminate or reduce the amount of electromagnetic disturbance generated by this machine.



This machine has been designed to operate in an industrial area. The operator must install and operate this equipment as described in this manual. If any electromagnetic disturbances are detected the operator must put in place corrective actions to eliminate these disturbances with, if necessary, assistance from Lincoln Electric. This equipment does not comply with IEC 61000-3-12. If it is connected to a public low-voltage system, it is responsibility of the installer or user of the equipment to ensure, by consultation with the distribution network operator if necessary, that the equipment may be connected.

Before installing the machine, the operator must check the work area for any devices that may malfunction because of electromagnetic disturbances. Consider the following.

- Input and output cables, control cables, and telephone cables that are in or adjacent to the work area and the machine.
- Radio and/or television transmitters and receivers. Computers or computer controlled equipment.
- Safety and control equipment for industrial processes. Equipment for calibration and measurement.
- Personal medical devices like pacemakers and hearing aids.
- Check the electromagnetic immunity for equipment operating in or near the work area. The operator must be sure that all equipment in the area is compatible. This may require additional protection measures.
- The dimensions of the work area to consider will depend on the construction of the area and other activities that are taking place.

Consider the following guidelines to reduce electromagnetic emissions from the machine.

- Connect the machine to the input supply according to this manual. If disturbances occur it may be necessary to take additional precautions such as filtering the input supply.
- The output cables should be kept as short as possible and should be positioned together. If possible connect the work piece to ground in order to reduce the electromagnetic emissions. The operator must check that connecting the work piece to ground does not cause problems or unsafe operating conditions for personnel and equipment.
- Shielding of cables in the work area can reduce electromagnetic emissions. This may be necessary for special applications.

WARNING

The Class A equipment is not intended for use in residential locations where the electrical power is provided by the public low-voltage supply system. There can be potential difficulties in ensuring electromagnetic compatibility in those locations, due to conducted as well as radio-frequency disturbances.



Electromagnetic Compatibility (EMC) for 220TPX

01/11

This machine has been designed in accordance with all relevant directives and standards. However, it may still generate electromagnetic disturbances that can affect other systems like telecommunications (telephone, radio, and television) or other safety systems. These disturbances can cause safety problems in the affected systems. Read and understand this section to eliminate or reduce the amount of electromagnetic disturbance generated by this machine.



This machine has been designed to operate in an industrial area. The operator must install and operate this equipment as described in this manual. If any electromagnetic disturbances are detected the operator must put in place corrective actions to eliminate these disturbances with, if necessary, assistance from Lincoln Electric. This equipment is compliant with EN 61000-3-12 and EN 61000-3-11 if the public low voltage system impedance at the point of common coupling is lower than $0,322 \Omega$. It is the responsibility of the installer or user of the equipment to ensure, by consultation with the distribution network operator if necessary, that the system impedance complies with the impedance restrictions.

Before installing the machine, the operator must check the work area for any devices that may malfunction because of electromagnetic disturbances. Consider the following.

- Input and output cables, control cables, and telephone cables that are in or adjacent to the work area and the machine.
- Radio and/or television transmitters and receivers. Computers or computer controlled equipment.
- Safety and control equipment for industrial processes. Equipment for calibration and measurement.
- Personal medical devices like pacemakers and hearing aids.
- Check the electromagnetic immunity for equipment operating in or near the work area. The operator must be sure that all equipment in the area is compatible. This may require additional protection measures.
- The dimensions of the work area to consider will depend on the construction of the area and other activities that are taking place.

Consider the following guidelines to reduce electromagnetic emissions from the machine.

- Connect the machine to the input supply according to this manual. If disturbances occur it may be necessary to take additional precautions such as filtering the input supply.
- The output cables should be kept as short as possible and should be positioned together. If possible connect the work piece to ground in order to reduce the electromagnetic emissions. The operator must check that connecting the work piece to ground does not cause problems or unsafe operating conditions for personnel and equipment.
- Shielding of cables in the work area can reduce electromagnetic emissions. This may be necessary for special applications.

WARNING





The Class A equipment is not intended for use in residential locations where the electrical power is provided by the public low-voltage supply system. There can be potential difficulties in ensuring electromagnetic compatibility in those locations, due to conducted as well as radio-frequency disturbances.









WARNING

This equipment must be used by qualified personnel. Be sure that all installation, operation, maintenance and repair procedures are performed only by qualified person. Read and understand this manual before operating this equipment. Failure to follow the instructions in this manual could cause serious personal injury, loss of life, or damage to this equipment. Read and understand the following explanations of the warning symbols. Lincoln Electric is not responsible for damages caused by improper installation, improper care or abnormal operation.

	<p>WARNING: This symbol indicates that instructions must be followed to avoid serious personal injury, loss of life, or damage to this equipment. Protect yourself and others from possible serious injury or death.</p>
	<p>READ AND UNDERSTAND INSTRUCTIONS: Read and understand this manual before operating this equipment. Arc welding can be hazardous. Failure to follow the instructions in this manual could cause serious personal injury, loss of life, or damage to this equipment.</p>
	<p>ELECTRIC SHOCK CAN KILL: Welding equipment generates high voltages. Do not touch the electrode, work clamp, or connected work pieces when this equipment is on. Insulate yourself from the electrode, work clamp, and connected work pieces.</p>
	<p>ELECTRICALLY POWERED EQUIPMENT: Turn off input power using the disconnect switch at the fuse box before working on this equipment. Ground this equipment in accordance with local electrical regulations.</p>
	<p>ELECTRICALLY POWERED EQUIPMENT: Regularly inspect the input, electrode, and work clamp cables. If any insulation damage exists replace the cable immediately. Do not place the electrode holder directly on the welding table or any other surface in contact with the work clamp to avoid the risk of accidental arc ignition.</p>
	<p>ELECTRIC AND MAGNETIC FIELDS MAY BE DANGEROUS: Electric current flowing through any conductor creates electric and magnetic fields (EMF). EMF fields may interfere with some pacemakers, and welders having a pacemaker shall consult their physician before operating this equipment.</p>
	<p>CE COMPLIANCE: This equipment complies with the European Community Directives.</p>
 <p><small>Optical radiation-emission Category 2 (EN 12191)</small></p>	<p>ARTIFICIAL OPTICAL RADIATION: According with the requirements in 2006/25/EC Directive and EN 12198 Standard, the equipment is a category 2. It makes mandatory the adoption of Personal Protective Equipments (PPE) having filter with a protection degree up to a maximum of 15, as required by EN169 Standard.</p>
	<p>FUMES AND GASES CAN BE DANGEROUS: Welding may produce fumes and gases hazardous to health. Avoid breathing these fumes and gases. To avoid these dangers the operator must use enough ventilation or exhaust to keep fumes and gases away from the breathing zone.</p>
	<p>ARC RAYS CAN BURN: Use a shield with the proper filter and cover plates to protect your eyes from sparks and the rays of the arc when welding or observing. Use suitable clothing made from durable flame-resistant material to protect you skin and that of your helpers. Protect other nearby personnel with suitable, non-flammable screening and warn them not to watch the arc nor expose themselves to the arc.</p>

	<p>WELDING SPARKS CAN CAUSE FIRE OR EXPLOSION: Remove fire hazards from the welding area and have a fire extinguisher readily available. Welding sparks and hot materials from the welding process can easily go through small cracks and openings to adjacent areas. Do not weld on any tanks, drums, containers, or material until the proper steps have been taken to insure that no flammable or toxic vapors will be present. Never operate this equipment when flammable gases, vapors or liquid combustibles are present.</p>
	<p>WELDED MATERIALS CAN BURN: Welding generates a large amount of heat. Hot surfaces and materials in work area can cause serious burns. Use gloves and pliers when touching or moving materials in the work area.</p>
	<p>CYLINDER MAY EXPLODE IF DAMAGED: Use only compressed gas cylinders containing the correct shielding gas for the process used and properly operating regulators designed for the gas and pressure used. Always keep cylinders in an upright position securely chained to a fixed support. Do not move or transport gas cylinders with the protection cap removed. Do not allow the electrode, electrode holder, work clamp or any other electrically live part to touch a gas cylinder. Gas cylinders must be located away from areas where they may be subjected to physical damage or the welding process including sparks and heat sources.</p>
<p>HF</p>	<p>CAUTION: The high frequency used for contact-free ignition with TIG (GTAW) welding, can interfere with the operation of insufficiently shielded computer equipment, EDP centers and industrial robots, even causing complete system breakdown. TIG (GTAW) welding may interfere with electronic telephone networks and with radio and TV reception.</p>
	<p>SAFETY MARK: This equipment is suitable for supplying power for welding operations carried out in an environment with increased hazard of electric shock.</p>

The manufacturer reserves the Right to make changes and/or improvements in design without upgrade at the same time the operator's manual.

Installation and Operator Instructions

General Description

Invertec 170TX/TPX and 220TPX are constant current, continuous control arc welding power sources for stick and tig process. They provide superior and reliable starting characteristics and arc stability.

The 220TPX has a PFC input that reduces the input supply current requirements and allows wide input voltage range operation.

Read this entire section before installation or operation of the machine.

Location and Environment

This machine will operate in harsh environments. However, it is important that simple preventative measures are followed to assure long life and reliable operation.

- Do not place or operate this machine on a surface with an incline greater than 15° from horizontal.
- Do not use this machine for pipe thawing.
- This machine must be located where there is free circulation of clean air without restrictions for air movement to and from the air vents. Do not cover the machine with paper, cloth or rags when switched on.
- Dirt and dust that can be drawn into the machine should be kept to a minimum.
- This machine has a protection rating of IP23. Keep it dry when possible and do not place it on wet ground or in puddles.
- Locate the machine away from radio controlled machinery. Normal operation may adversely affect the operation of nearby radio controlled machinery, which may result in injury or equipment damage. Read the section on electromagnetic compatibility in this manual.
- Do not operate in areas with an ambient temperature greater than 40°C.

Input Supply Connection

The machines are a wide input voltage range: before installing and turning it on, check the supplied input voltage, phase, and frequency. The allowable input voltage range, phase, and frequency are indicated in the technical specification section of this manual and on the machine's rating plate. Be sure that the machine is grounded.

Make sure the power available at the input connection is adequate for normal operation of the machine. The fuse rating and cable sizes are both indicated in the technical specification section of this manual.

Input Supply From Engine Driven Generators

The machine is designed to operate on engine driven generators as long as the auxiliary can supply adequate voltage, frequency and power as indicated in the "Technical Specification" section of this manual. The auxiliary supply of the generator must also meet the following conditions:

- Vac peak voltage: below 410V.
- Vac frequency: in the range of 50 and 60Hz.
- RMS voltage of the AC waveform:
 - from 115V to 230V ± 15%.(220TPX)
 - 230vac ± 15%.(170TX/TPX)

It is important to check these conditions because many engine driven generators produce high voltage spikes. Operation of this machine with engine driven generators not conforming to these conditions is not recommended and may damage the machine.

Output Connections

A quick disconnect system using Twist-Mate™ cable plugs is used for the welding cable connections. Refer to the following sections for more information on connecting the machine for operation of stick welding (MMA) or TIG welding (GTAW).

- (+) Positive Quick Disconnect: Positive output connector for the welding circuit.
- (-) Negative Quick Disconnect: Negative output connector for the welding circuit.

Stick Welding (MMA)

This machine does not include a MMA welding kit cables, but may be purchased separately. Refer to the accessories section for more information.

First determine the proper electrode polarity for the electrode to be used. Consult the electrode data for this information. Then connect the output cables to the output terminals of the machine for the selected polarity. Shown here is the connection method for DC(+) welding.

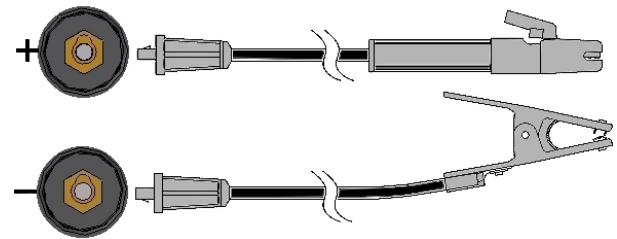

Connect the electrode cable to the (+) terminal and the work clamp to the (-) terminal. Insert the connector with the key lining up with the keyway and rotate approximately ¼ turn clockwise. Do not over tighten.

For DC(-) welding, switch the cable connections at the machine so that the electrode cable is connected to (-) and the work clamp is connected to (+).

TIG Welding (GTAW)

This machine does not include a TIG torch necessary for TIG welding, but one may be purchased separately. Refer to the accessories section for more information.

Most TIG welding is done with DC(-) polarity shown here. If DC(+) polarity is necessary switch the cable connections at the machine.

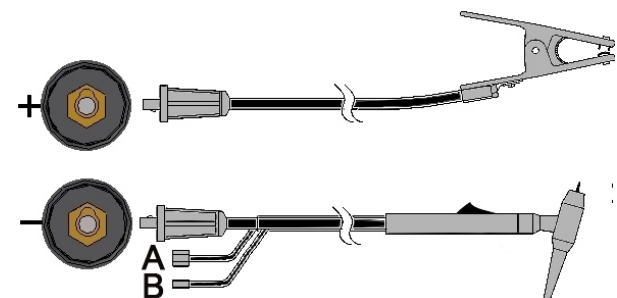

Connect the torch cable to the (-) terminal of the machine and the work clamp to the (+) terminal. Insert the connector with the key lining up with the keyway and rotate approximately ¼ turn clockwise. Do not over tighten. Finally, connect the gas hose from the TIG torch to the gas connector (B) on the front of the machine. If necessary, an extra gas connector for the fitting on the front of the machine is included in the package. Next, connect the fitting on the back of the machine to a gas regulator on the cylinder of gas to be used. An input gas line and the required fittings are also included in the package. Connect the TIG torch trigger to the trigger connector (A) on the front of the machine.

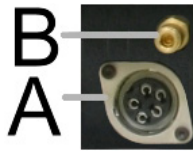

Remote Control Connection

Refer to the accessories section for a list of remote controls. If a remote control is used, it will be connected to the remote connector on the front of the machine. The machine will automatically detect the remote control, turn on the REMOTE LED, and switch to remote control mode. More information on this mode of operation will be given in the next section.



Rear Panel

A. **Power Switch:** It turns ON / OFF the input power to the machine.

B. **Input cable:** Connect it to the mains.

C. **Fan:** Do not obstruct or filter the fan inlet. The "F.A.N." (Fan As Needed) feature automatically regulates the speed of the fan. If the Machine doesn't weld for more than 5 minutes, it will enter Green Mode.

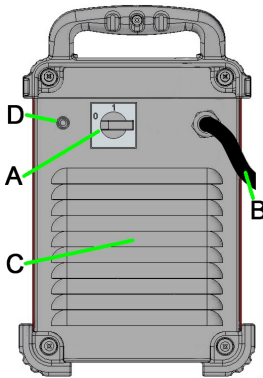

Green Mode

Green Mode is a feature that puts the machine in a stand-by condition:

- The output is disabled
- The fan is turned OFF
- Only the Power ON LED remains ON.
- A moving red dash is shown in the display

This reduces the amount of dirt that can be drawn inside the Machine and the power consumption.

To restore the Machine simply restart to weld.

NOTE: Green Mode long time condition: each 10min of continuous Green Mode the fan runs for 1min.

D. **Gas Inlet:** Connector for the TIG shielding gas. Use the supplied gas line and connector to connect the machine to the gas source. The gas source must have a pressure regulator and flow gage installed.

Controls and Operational Features

Machine Start-Up:

When the machine is turned ON an auto-test is executed; during this test all the LEDs turn ON in sequence; at the same time the displays show "333" and then "888".

- The Machine is ready to operate when on the Front Control Panel lights up the "Power ON" LED, the "A" LED (placed on the middle of the synoptic) with one of the LED of the Welding "MODE" command. This is the minimum condition: depending by the welding selection others LEDs may be ON.

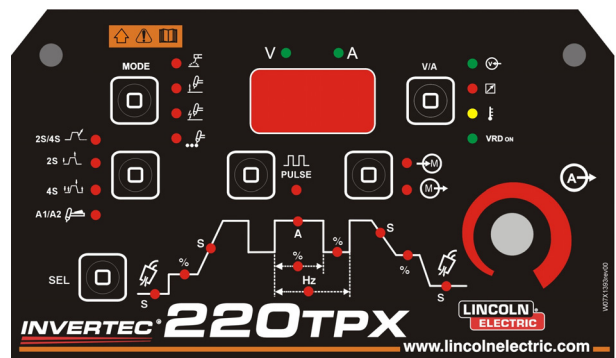
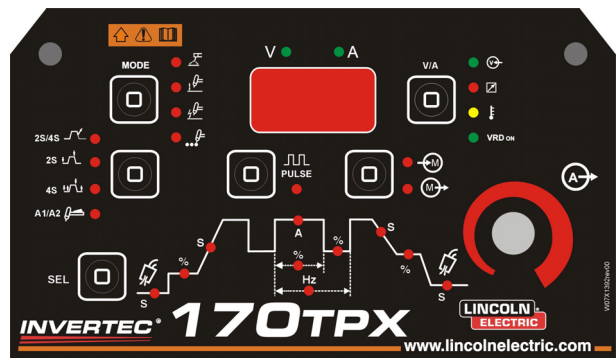
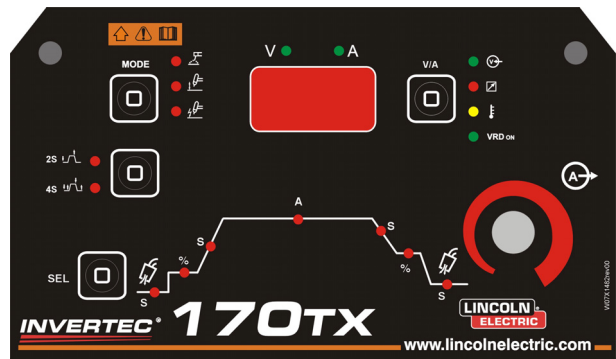

Front Panel Indicators and Controls

Power ON LED:



This LED blinks during the machine start-up and lights up steadily when the machine is ready to operate.

If the Input Voltage Overrange protection becomes active, the Power ON LED starts blinking and an error code is shown on the displays. The machine restarts automatically when the Input Voltage returns in the correct range. For further detail read the Error Codes and Troubleshooting section.

Remote LED:



This indicator will turn on when a Remote command is connected to the machine via the remote control connector.

If a Remote command is connected to the Machine, the Output Current knob operates in two different modes: STICK and TIG:

- **STICK mode:** with a Remote command connected the output of the machine is ON. A Remote Amptrol or Pedal are allowed (trigger is ignored).



Connecting the Remote command excludes the Output Current Knob of the Machine's user interface. Through the Remote command is available the full Output Current Range.

- **TIG mode:** in Local and remote mode the output of the machine is OFF. A Trigger is necessary to enable the output.



For 170TX/TPX: The Output Current range selectable from the Remote command depends by the Machine's user interface Output Current Knob. Eg.: if the Output Current is set to 100A with the Machine's user interface Output Current Knob, the Remote command will adjust the Output Current from a minimum of 2A to a maximum of 100A.

For 220TPX: The Output Current range selectable from the Remote command depends by the Machine's user interface Output Current Knob. Eg.: if the Output Current is set to 100A with the Machine's user interface Output Current Knob, the Remote command will adjust the Output Current from the minimum current to a maximum of 100A.

The output current set by Output Current Knob is shown for 3 second whenever the knob is moved. After the 3 second the value shows is the current select by the Remote command.

Remote Pedal: For a correct use, the "option 30" must be enabled in the setup menu:

- 2-step sequence is automatically selected
- Upslope / Downslope ramps and Restart are disabled.
- Spot, Bi-Level and 4-step functions aren't selectable

(Normal operation is restored when the Remote command is disconnected.)

Thermal LED:



This indicator will turn on when the machine is overheated and the output has been disabled. This normally occurs when the duty cycle of the machine has been exceeded. Leave the machine on to allow the internal components to cool. When the indicator turns off, normal operation is again possible.

VRD LED (enabled on Australian Machines only):



This machine is provided by VRD (Voltage Reduction Device) function: this reduces the voltage at the output leads.

The VRD function is enabled by factory default only on machines that meet the AS 1674.2 Australian Standards. (C-Tick logo "C" on/near the Rating Plate applied on the machine).

The VRD LED is ON when the Output Voltage is below 12V with the Machine at idle (no welding time).

For others machines this function is disabled (the LED is always OFF).

Mode Pushbutton:

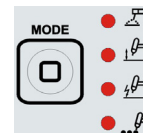

This pushbutton changes the welding modes of the machine:

- Stick (SMAW)
- Lift TIG (GTAW)
- HF TIG (GTAW)
- Spot TIG (GTAW)

The Spot TIG feature is selectable only if the "option 10" is previously enabled in the Setup Menu. See "Setup menu" section for options enabling / disabling.

Each welding mode is detailed in the Operating instruction section.

Trigger Mode Pushbutton:

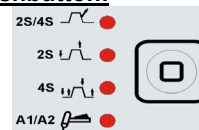

This pushbutton changes the trigger sequence in TIG welding mode:

- 2-step / 4-step with restart This option is not selectable by the Trigger Pushbutton and, if enabled, operates with 2 or 4 step mode:



This indicator will turn on if the restart option is enabled for the current TIG trigger mode. Restart can be enabled separately for 2-step and 4-step modes from the Setup Menu. More information about restart is available in the Operating instruction section.

- 2-step
- 4-step
- Bi-Level

Each trigger mode is detailed in the Operating instruction section.

SEL Pushbutton:



The SElect pusbutton is used to scroll the TIG welding parameters. At each pressure the relevant led is switched on and the displays show the current value of the parameter. If a parameter is disabled for the current mode of working it will be skipped. The user can then modify this value turning the Output Current knob. If no change is made after a timeout (4s), the displays and LEDs will revert to the default state, where the Output Current knob sets the output current.

Memory Pushbutton:



This pusbutton allows to store (→M) or recall (M→) TIG welding programs. 9 memory records (P01 to P9) are available for the user.

To store or recall a record: Push until the Store (→M) or Recall (M→) LED is ON according to the desired operation

Into the follow display



will appear, turning the knob, from P01 to P10, all the possible programs.

Then keep pushed for 4s



The Memory pushbutton is disabled during welding.

See “List of parameters and Factory stored programs” section below for a complete list of factory stored programs.

Pulsing Mode Pushbutton:



In the TIG welding modes, this pusbutton turns the pulsing function ON. When active, the LED next to the pusbutton is turned ON. In Stick welding mode, this command is disabled.

When Pulse is active is possible to set Duty cycle (%), Frequency (Hz) and Background (%) parameters. During TIG welding is not possible switch ON or OFF the Pulse command: if ON, during welding is possible operates on the values of Duty, Frequency and Background current.

Output Current Knob:

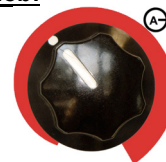

It is used to set the Output Current used during welding.

This knob is also a multi-purpose command: see the “Operating Instruction” section for a description of how to use this command for parameters selection.

V & A Display:

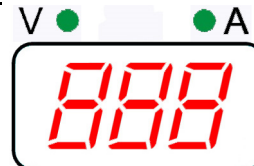

If the A LED is ON the meter displays the preset welding current (A) before welding and the actual welding current during welding. If the V LED is ON the meter shows the voltage (V) at the output leads. To switch between Current and Voltage visualization:

Action	Visualization
Press A/V	Current
Press A/V	Voltage

A flashing dot on the Display indicates that the value read is the average value of the previous welding time. This feature shows the average value for 5seconds after every welding time.

If a remote control is connected (the Remote LED is ON), the meter (A) indicates the preset and the actual welding current following the instruction explained in the “Remote LED” description above.

The Display can also show the following set of characters:

SOF SOFT	CR CRISP
P PROGRAM 01,10	For program records
E 01,99	For error codes

See “Operating Instruction” section for a detailed description of the functions described by these indications.

Operating Instruction

Stick (SMAW) Welding

To select Stick welding:

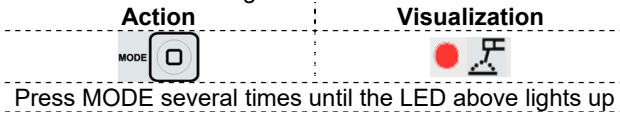

When the Stick position is selected, the following welding features are enabled:

- Hot Start: This is a temporary increase in the output current during the start of the stick welding process. This helps ignite the arc quickly and reliably.
- Anti-Sticking: This is a function which decreases the output current of the machine to a low level when the operator makes an error and sticks the electrode to the work piece. This decrease in current allows the operator to remove the electrode from the electrode holder without creating large sparks which can damage the electrode holder.
- Auto Adaptive Arc Force: this function increases temporary the output current, used to clear intermittent connections between the electrode and the weld puddle that occur during stick welding.

This is an active control feature that guarantees the best arrangement between the arc stability and spatter presence. The feature "Auto Adaptive Arc Force" has instead of a fixed or manual regulation, an automatic and multilevel setting: its intensity depends by the output voltage and it is calculated in real time by the microprocessor where are also mapped the Arc Force levels. The control measure in each instant the output voltage and it determines the amount of the peak of current to apply; that value is enough to breaks the metal drop that is being transferred from the electrode to the workpiece as to guarantee the arc stability, but not too high to avoid spatters around the welding puddle. That means:

- Electrode / workpiece sticking prevention, also with low current values.
- Spatters reduction.

The welding operations are simplified and the welded joints looks better, also if not brushed after the welding.

In Stick mode, two different setup are available:

- SOFT Stick: For a welding with a low spatter presence.
- CRISP Stick (Factory Default): For an aggressive welding, with an increased Arc stability.

To switch between Soft and Crisp:

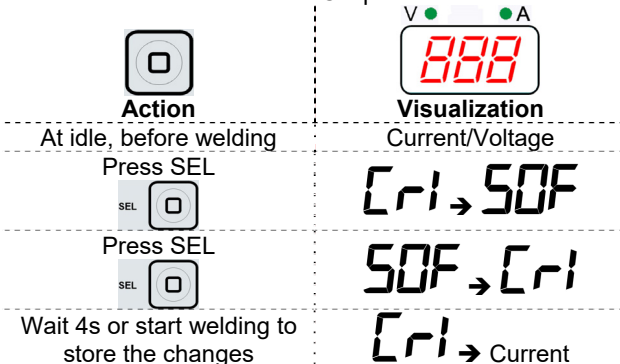

Lift TIG (GTAW welding)

To select Lift TIG welding:

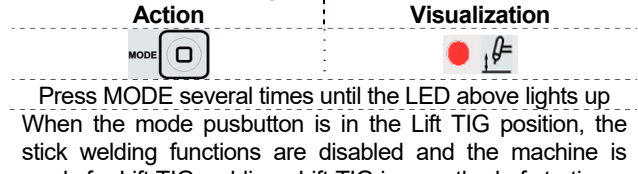

When the mode pushbutton is in the Lift TIG position, the stick welding functions are disabled and the machine is ready for Lift TIG welding. Lift TIG is a method of starting a TIG weld by first pressing the TIG torch electrode on the work piece in order to create a low current short circuit. Then, the electrode is lifted from the work piece to start the TIG arc.

HF TIG (GTAW welding)

To select HF TIG welding:

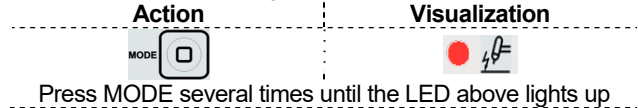

When the mode pushbutton is in HF TIG position, the stick welding functions are disabled and the machine is ready for HF TIG welding. During the HF TIG mode, the TIG arc is started by HF without pressing the electrode on the work piece. The HF used for starting the TIG arc will remain on for 3 seconds; if the arc is not started in this time limit, the trigger sequence must be restarted.

The HF arc start strength can be adjusted in the setup menu by changing the value of option 40. Four arc start strengths are available, ranging from 1 (smooth, suitable for thin electrodes) to 4 (strong, suitable for thick electrodes). The default value for this option is 3.

Spot TIG (GTAW welding)

The Spot TIG feature is selectable only if the "option 10" is previously enabled in the Setup Menu.

To select Spot TIG welding:

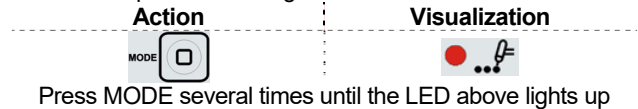

This welding mode is especially thought to tack or weld thin materials. It uses HF start and immediately delivers the set current without any upslope/downslope. The welding time can be either linked to the trigger or set with the spot time control.

If the spot time ("option 11" of the Setup Menu) is enabled from the setup menu, in order to change the spot time:

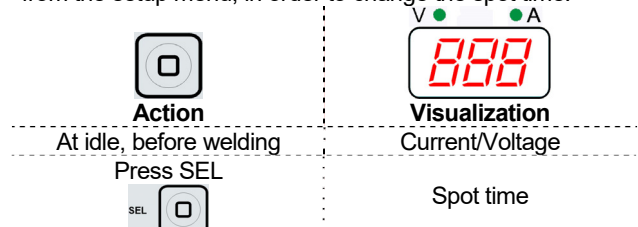

At this point the spot time can be adjusted by turning the Output Current knob. Setting the spot time to 0 will disable the fixed time function and the welding time will be linked to the TIG torch trigger.

NOTE: The HF start strength is adjusted by setup option 40, as described in the HF Tig section above. See "Setup menu" section for options enabling / disabling.

Tig Welding Sequences (only model 220TPX-170TPX)



At each pressure of the SEL pushbutton the LEDs lights up in the following order:

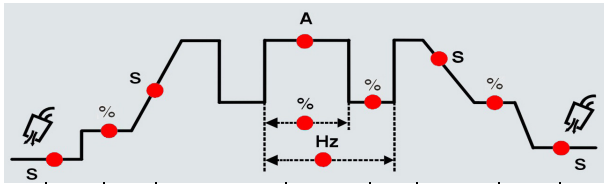

1	S						
2		%					
3			S				
4				A			
4a				%			
4b				Hz			
4d					%		
5						S	
6							%
7							S

1	PREFLOW In the TIG welding modes, this function controls the shielding gas Preflow time. In Stick welding mode, this is not used.
2	START CURRENT This function controls the initial current when a TIG welding is started. For an explanation of the Start operation, refer to the trigger sequences explained below.
3	UPSLOPE In the TIG welding modes, this function controls the linear increase of the current from Start to Set Current. Refer to the trigger sequence section below to understand how Upslope is activated. In Stick welding mode, this is not used.
4	SET CURRENT This function is used to set the Output Current used during welding.
4a	DUTY CYCLE (PULSING ON-TIME) When the pulse feature is ON, this function controls the pulsing on-time. During the on-time the output current is equal to the Set Current.
4b	FREQUENCY When the pulse feature is ON, this function controls the pulsing frequency, that is the square wave represented in the diagram above (Hz).
4d	BACKGROUND When the pulse feature is ON, this function controls the pulsing Background current. This is the current during the low portion of the pulse waveform.
5	DOWNSLOPE In the TIG welding modes, this function controls the linear decrease of the current from Set to Crater Current. Refer to the trigger sequence section below to understand how Downslope is activated. In Stick welding mode, this is not used.
6	CRATER This function controls the final current value after the Downslope. For an explanation of the Crater operation, refer to the trigger sequences explained below.
7	POSTFLOW In the TIG welding modes, this function controls the shielding gas Postflow time. In Stick welding mode, this is not used.

During welding the Sel pushbutton is enabled for the following functions:

- Output current
- Only if Pulse Function is active: is possible operates on the values of Duty (%), Frequency (Hz) and Background current (A).

The new parameter value is automatically saved.

Tig Welding Sequences (only model 170TX)



At each pressure of the SEL pushbutton the LEDs lights up in the following order:

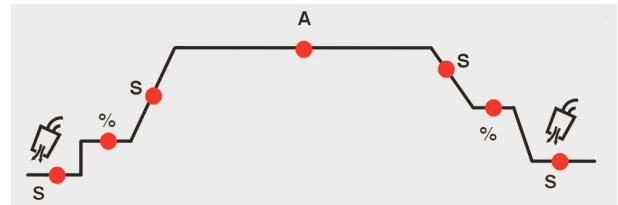

1	S						
2		%					
3			S				
4				A			
5						S	
6							%
7							S

1	PREFLOW In the TIG welding modes, this function controls the shielding gas Preflow time. In Stick welding mode, this is not used.
2	START CURRENT This function controls the initial current when a TIG welding is started. For an explanation of the Start operation, refer to the trigger sequences explained below.
3	UPSLOPE In the TIG welding modes, this function controls the linear increase of the current from Start to Set Current. Refer to the trigger sequence section below to understand how Upslope is activated. In Stick welding mode, this is not used.
4	SET CURRENT This function is used to set the Output Current used during welding.
5	DOWNSLOPE In the TIG welding modes, this function controls the linear decrease of the current from Set to Crater Current. Refer to the trigger sequence section below to understand how Downslope is activated. In Stick welding mode, this is not used.
6	CRATER This function controls the final current value after the Downslope. For an explanation of the Crater operation, refer to the trigger sequences explained below.
7	POSTFLOW In the TIG welding modes, this function controls the shielding gas Postflow time. In Stick welding mode, this is not used.





During welding the Sel pushbutton is not enabled.

The new parameter value is automatically saved.

TIG Trigger Sequences



TIG welding can be done in either the 2-step or 4-step mode. The specific sequences of operation for the trigger modes are explained below.

Legenda of the symbols used:

	Torch Pushbutton
	Output Current
	Gas Pre-flow
	Gas
	Gas Post-flow

2-Step Trigger Sequence

To select 2-Step sequence:

Action	Visualization
	

Press several times until the LED above lights up

With the 2-step trigger mode and a TIG welding mode selected, the following welding sequence will occur.

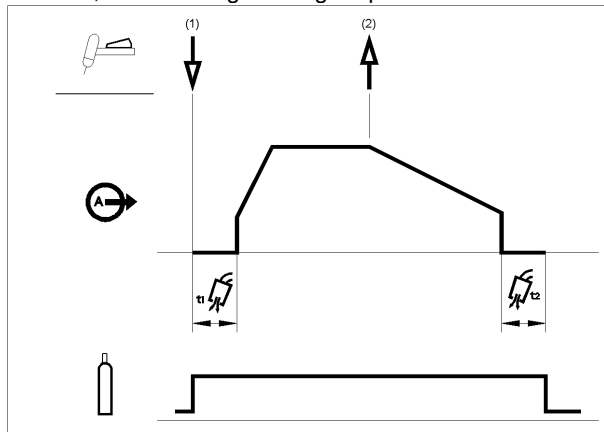

1. Press and hold the TIG torch trigger to start the sequence. The machine will open the gas valve to start the flow of the shielding gas. After the preflow time, to purge air from the torch hose, the output of the machine is turned ON. At this time the arc is started according to the selected welding mode. After the arc is started the output current will be increased at a controlled rate, or upslope time, until the Welding current is reached.

If the torch trigger is released during the upslope time the arc will stop immediately and the output of the machine is turned OFF.

2. Release the TIG torch trigger to stop welding. The machine will now decrease the output current at a controlled rate, or downslope time, until the Crater current is reached and the output of the machine is turned OFF.

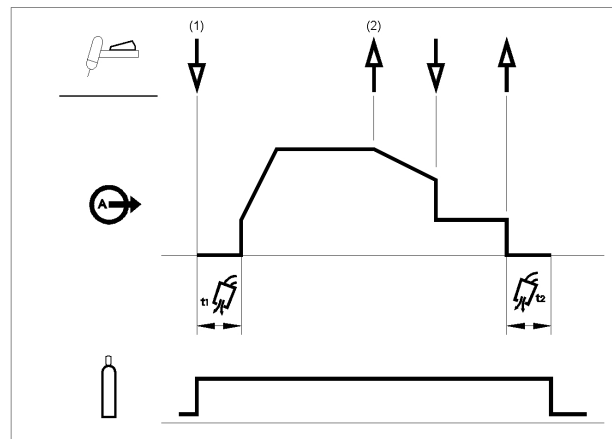

After the arc is turned OFF, the gas valve will remain open to continue the flow of the shielding gas to the hot electrode and work piece.



As shown above, it is possible to press and hold the TIG torch trigger a second time during downslope to end the downslope function and maintain the output current at the Crater current. When the TIG torch trigger is released the output will turn OFF and the postflow time will start. This operation sequence, 2-step with restart disabled, is the default setting from the factory.



2-Step Trigger Sequence with Restart Option

To select 2-Step with restart sequence:

Action	Visualization
	

See "Setup menu" section below

then:

	
--	---

Press several times until the LED above lights up

If the 2-step restart option is enabled from the setup menu the following sequence will occur:

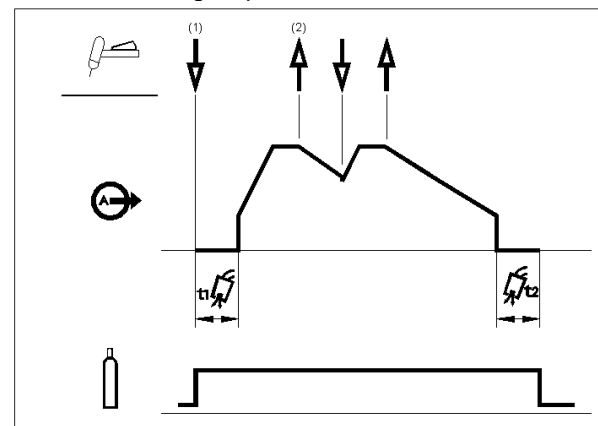

1. Press and hold the TIG torch trigger to start the sequence as described above.
2. Release the TIG torch trigger to start the downslope. During this time press and hold the TIG torch trigger to restart welding. The output current will increase again at a controlled rate until the Welding current is reached. This sequence can be repeated as many times as necessary. When the welding is complete release the TIG torch trigger. When the Crater current is reached the output of the machine is turned OFF.

4-Step Trigger Sequence

To select 4-Step sequence:

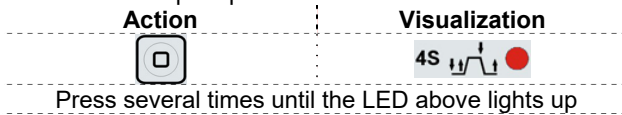

With the 4-step trigger mode and a TIG welding mode selected, the following welding sequence will occur.

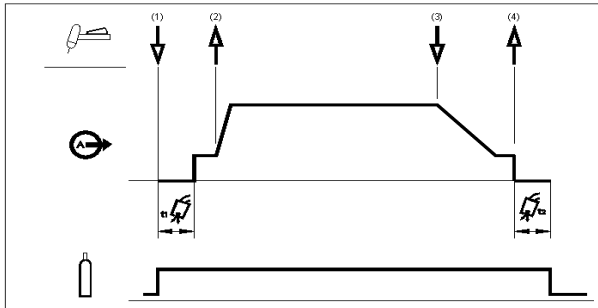

1. Press and hold the TIG torch trigger to start the sequence. The machine will open the gas valve to start the flow of the shielding gas. After the preflow time, to purge air from the torch hose, the output of the machine is turned ON. At this time the arc is started according to the selected welding mode. After the arc is started the output current will be at the Start current. This condition can be maintained as long as necessary.

If the Start current is not necessary, do not hold the TIG torch trigger as described at the beginning of this step. In this condition, the machine will pass from Step 1 to Step 2 when the arc is started.

2. Releasing the TIG torch trigger starts the upslope function. The output current will be increased at a controlled rate, or upslope time, until the Welding current is reached. If the torch trigger is pushed during the upslope time the arc will stop immediately and the output of the machine is turned OFF.
3. Press and hold the TIG torch trigger when the main part of the weld is complete. The machine will now decrease the output current at a controlled rate, or downslope time, until the Crater current is reached.
4. This Crater current can be maintained as long as necessary. When the TIG torch trigger is released the output of the machine is turned OFF and the postflow time will start.

As shown here, after the TIG torch trigger is quickly pressed and released from step 3A, it is possible to press and hold the TIG torch trigger another time to end the downslope time and maintain the output current at the Crater current. When the TIG torch trigger is released the output will turn OFF.

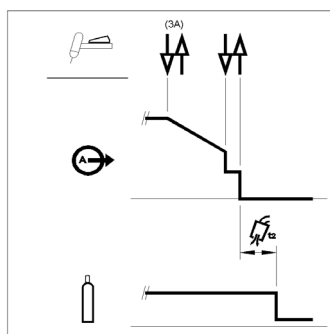

This sequence operation, 4-step with restart disabled, is the default setting from the factory.

4-Step Trigger Sequence with Restart Option

To select 4-Step with restart sequence:



then:

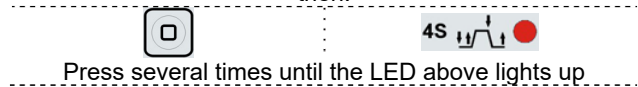

If 4-step restart is enabled from the setup menu the following sequence will occur for steps 3 and 4 (steps 1 and 2 are not altered by the restart option):

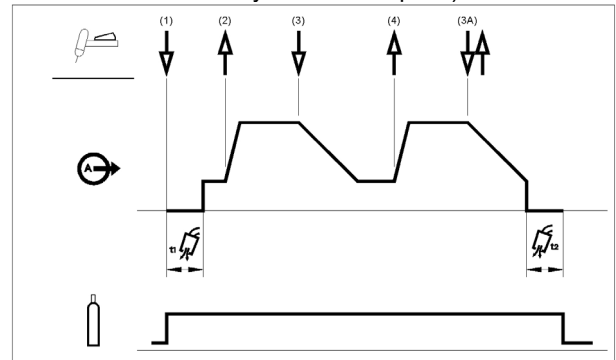

3. Press and hold the TIG torch trigger. The machine will now decrease the output current at a controlled rate, or downslope time, until the Crater current is reached.
4. Release the TIG torch trigger. The output current will again increase to the Welding current, like in step 2, to continue welding.

If the weld is completely finished, use the following sequence instead of step 3 described above.

- 3A. Quickly press and release the TIG torch trigger. The machine will now decrease the output current at a controlled rate, or downslope time, until the Crater current is reached and the output of the machine is turned OFF. After the arc is turned OFF the postflow time will start.

As shown here, after the TIG torch trigger is quickly pressed and released from step 3A, it is possible to press and hold the TIG torch trigger another time to end the downslope time and maintain the output current at the Crater current. When the TIG torch trigger is released the output will again increase to the Welding current, like in step 4, to continue welding. When the main part of the weld is complete go to step 3.

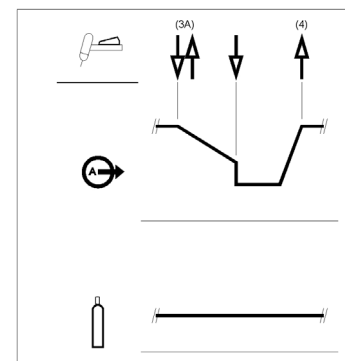

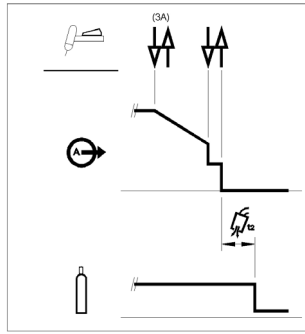

As shown here, again after the TIG torch trigger is quickly pressed and released from step 3A, it is possible to quickly press and release the TIG torch trigger a second time to end the downslope time and stop welding.



Bi-Level (A1/A2) Trigger sequence

The Bi-Level feature is selectable only if the “option 20” is previously enabled in the Setup Menu.

To select Bi-Level sequence:

Action	Visualization
	A1/A2  
Press several times until the LED above lights up	

With this sequence the arc is started as in the 4S sequence, this means that steps 1 and 2 are the same.

- Quickly press and release the TIG torch trigger. The machine will switch the current level from A1 to A2 (background current). Each time this trigger action is repeated the current level will switch between the two levels.
 - Press and hold the TIG torch trigger when the main part of the weld is complete. The machine will now decrease the output current at a controlled rate, or downslope time, until the Crater current is reached. This Crater current can be maintained as long as necessary.

NOTE: The Restart option and the Pulse function are not available for Bi-Level Trigger sequence.

Torch control functions

Valid only for 220TPX

The torch control functions are available if up/down module on the torch is assembled on torch and “Option 50” is enabled in the Setup Menu. There are two functions available:

Option 50 “Cur” change set current value:

Three operating modes, corresponding to different states of the machine, are identified:

- Before welding: pressing the UP or DOWN key causes a change of value of the Set current
- While welding: pressing the UP or DOWN key causes a change of value of the Set current during all phases of welding process except during the start functions, where the UP/DOWN function is masked.
- Pre/post Flow: pressing the UP or DOWN key causes a change of value of the Set current.

The change will be realized in two ways depending on pressed button time:

- Step function
Pressing the UP/DOWN button for a minimum time of 200ms and releasing it, causes the set current raises/falls of 1A.
- Ramp function
Pressing the UP/DOWN button for a time greater than 1 sec., the set current start to increase/decrease with a (5A/s) ramp. If press for more than 5 sec increase/decrease with a ramp of (10A/s).

The current ramp will end when the UP/DOWN button previously pressed is released.

When a remote (pedal or RC-pot) device is present, depending on welding process selected, the UP/DOWN behavior is different.

SMAW:

In SMAW welding mode, the remote device set the amperage setting in the whole range, bypassing the main control knob in front User interface. In that case the signals coming from UP/DOWN **are ignored**.

GTAW:

In GTAW mode of welding, the remote device set the percentage of the main set delivered by the machine. Regulating the main amperage, the UP/DOWN with remote device will work as described above.

Option 50 “Job” Change memory:

By pressing torch buttons user will be allowed to change over settings stored in memory locations from 1 to 9. The feature is not available during welding.

Setup menu

The setup menu contains more parameters that are hidden from the main control panel functionality.

To enter the Setup menu:

Push and hold "SEL" and "MODE" pushbuttons



Keep "SEL" + "MODE" pushed until the display shows



Then release the Pushbuttons



now is shown the **option number "00"**

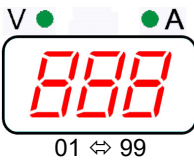

Select the desired option: on the left display is shown the option number



then press "SEL" to confirm



Now enable, disable or change the option value: on the right display is shown the option status



Save the desired option by pressing the "SEL" pushbutton



To exit the setup menu select the 00 option and keep the SEL button pushed for 5 seconds until normal operation is resumed.



List of menu options















	Options	Options Value
00	Exit point	--
01	2-step restart	On/Off
02	4-step restart	On/Off
10	Spot welding	On/Off
11	Spot fixed time	On/Off
20	Bi-Level	On/Off
30	Foot Pedal	On/Off
40	Arc start strenght	1/2/3/4
50*	Torch control function	Off/Cur/Job
51*	Limit max current	Off/[Ampere]
52*	Limit min current	Off/[Ampere]
99	Reset to factory default	

* valid only for 220TPX

To change a setting push SEL, then rotate the encoder (Output Current Knob) to modify the setting, and push SEL again to confirm the new value.

Error Codes and troubleshooting.

If an error occurs, turn Off the machine, wait for a few seconds, then turn ON again. If the error remains, a maintenance is required. Please contact the nearest technical service center or Lincoln Electric and report the error code displayed on the meter of the Front Panel.

Error code table	
01	<p>Input voltage too low</p> <p>  LED is blinking.</p> <p>Indicates that an Input Undervoltage protection is active; the Machine restarts automatically when the Input Voltage returns in the correct range.</p>
02	<p>Input voltage too high</p> <p>  LED is blinking.</p> <p>Indicates that an Input Voltage Overvoltage protection is active; the Machine restarts automatically when the Input Voltage returns in the correct range.</p>
03	<p>Wrong input connection</p> <p>  LED is blinking.</p> <p>Indicates that the machine is incorrectly wired.</p> <p>To restore the machine:</p> <ul style="list-style-type: none"> • Turn OFF the machine and check the input connection.
05	<p>DC bus short circuit</p> <p>    LEDs blink slowly together.</p> <p>Indicates that an Internal Power Circuitry fault condition is detected.</p> <p>To restore the machine: Turn OFF then ON the Mains Switch to restart the machine.</p>
06	<p>Inverter voltage lock out</p> <p>    LEDs blink alternatively.</p> <p>Indicates that an Internal Auxiliary Voltage fault condition is detected.</p> <p>To restore the machine:</p> <ul style="list-style-type: none"> • Turn OFF then ON the Mains Switch to restart the machine.
10	<p>Fan fault</p> <p>The cooling fan is blocked or faulty.</p> <p>To restore the machine:</p> <ul style="list-style-type: none"> • Turn OFF the Mains Switch then and check if the fan is being blocked by something that stops the blades. <p style="text-align: center;"> WARNING</p> <ul style="list-style-type: none"> • DO NOT OPEN THE MACHINE! Perform the check through the air inlet louvers placed in the machine rear side. • DO NOT INTRODUCE OBJECTS INSIDE OF THE LOUVERS! Danger of electric shock. <ul style="list-style-type: none"> • Turn ON the Mains Switch to restart the machine and make a short weld, in order to verify that the fan is restarted. <p>If the fan remains inactive a maintenance from a Service is necessary.</p>

Maintenance

WARNING

For any maintenance or repair operations it is recommended to contact the nearest technical service center or Lincoln Electric. Maintenance or repairs performed by unauthorized service centers or personnel will null and void the manufacturers warranty.

The frequency of the maintenance operations may vary in accordance with the working environment. Any noticeable damage should be reported immediately.

- Check cables and connections integrity. Replace, if necessary.
- Keep clean the machine. Use a soft dry cloth to clean the external case, especially the airflow inlet / outlet louvers.

WARNING

Do not open this machine and do not introduce anything into its openings. Power supply must be disconnected from the machine before each maintenance and service. After each repair, perform proper tests to ensure safety.

Customer Assistance Policy



The business of The Lincoln Electric Company is manufacturing and selling high quality welding equipment, consumables, and cutting equipment. Our challenge is to meet the needs of our customers and to exceed their expectations. On occasion, purchasers may ask Lincoln Electric for advice or information about their use of our products. We respond to our customers based on the best information in our possession at that time. Lincoln Electric is not in a position to warrant or guarantee such advice, and assumes no liability, with respect to such information or advice. We expressly disclaim any warranty of any kind, including any warranty of fitness for any customer's particular purpose, with respect to such information or advice. As a matter of practical consideration, we also cannot assume any responsibility for updating or correcting any such information or advice once it has been given, nor does the provision of information or advice create, expand or alter any warranty with respect to the sale of our products

Lincoln Electric is a responsive manufacturer, but the selection and use of specific products sold by Lincoln Electric is solely within the control of, and remains the sole responsibility of the customer. Many variables beyond the control of Lincoln Electric affect the results obtained in applying these types of fabrication methods and service requirements.



Subject to Change – This information is accurate to the best of our knowledge at the time of printing. Please refer to www.lincolnelectric.com for any updated information.

List of parameters and Factory stored programs



List of parameters and Factory Configuration program:

Parameter	Factory Configuration	Selectable Value Range 	Displayed value 
Preflow	0.3s	0 - 5s (step 0.1s)	Current selected value (s)
Start Current	Lift TIG 2-step: 22A	Not adjustable	Current selected value (% of set current)
	Lift TIG 4-step: 30% HF TIG 2-step: 30% HF TIG 4-step: 30%	5 - 200%	
Upslope	0.1s	0 - 5s (step 0.1s)	Current selected value (s)
Set Current ¹	50A	5 - 170A (Stick) (220TPX) 2 - 220A (TIG) (220TPX) 5 - 170A (Stick) (170TX/TPX) 5 - 170A (TIG) (170TX/TPX)	Current selected value (A)
Duty Cycle (ONLY 220/170 TPX)	50%	10 - 90% (step 5%) (f>300Hz Duty=50%)	Current selected value (%)
Frequency (f) (ONLY 220/170 TPX)	50Hz	0.1 - 10Hz (step 0.1Hz) 10 - 300Hz (step 1Hz) 300 - 500Hz (step 10Hz)	Current selected value (Hz)
Background (ONLY 220/170 TPX)	30%	10 - 90% (step 1%)	Current selected value (% of set current)
Downslope	0s	0 - 20s (step 0.1s)	Current selected value (s)
Crater	30%	5 - 100% (step 1%)	Current selected value (% of set current)
Postflow	5s	0 - 30s (step 1s)	Current selected value (s)

TIG SPOT WELDING (to previously enable with option 10 in Setup menu)

Parameter	Features	Selectable Value Range 	Displayed value 
Spot Current (ONLY 220/170 TPX)	Trigger = 2-step No restart function enabled Preflow time = 0s Upslope time = 0s Downslope time = 0s Postflow time = 0s	2 - 220A (220TPX) 5 - 170A (170TPX)	Current selected value (A)

TIG SPOT FIXED TIME (to previously enable with option 11 in Setup menu)

Parameter	Features	Selectable Value Range 	Displayed value 
Spot Time	0 (manual trigger)	0 - 5s (step 0.1s)	Welding time (s)

¹It's possible change the maximum and minimum selectable current with "Option 51" and "Option 52" in the Setup Menu. If [Off] the set current are the "factory default", otherwise it is possible set another current.

WEEE

07/06

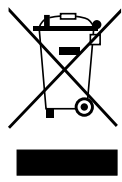

Do not dispose of electrical equipment together with normal waste!

In observance of European Directive 2012/19/EC on Waste Electrical and Electronic Equipment (WEEE) and its implementation in accordance with national law, electrical equipment that has reached the end of its life must be collected separately and returned to an environmentally compatible recycling facility. As the owner of the equipment, you should get information on approved collection systems from our local representative.

By applying this European Directive you will protect the environment and human health!

Spare Parts

12/05

Part List reading instructions

- Do not use this part list for a machine if its code number is not listed. Contact the Lincoln Electric Service Department for any code number not listed.
- Use the illustration of assembly page and the table below to determine where the part is located for your particular code machine.
- Use only the parts marked "X" in the column under the heading number called for in the assembly page (# indicate a change in this printing).

First, read the Part List reading instructions above, then refer to the "Spare Part" manual supplied with the machine, that contains a picture-descriptive part number cross-reference.

REACH

11/19

Communication in accordance with Article 33.1 of Regulation (EC) No 1907/2006 – REACH.

Some parts inside this product contain:

Bisphenol A, BPA,	EC 201-245-8, CAS 80-05-7
Cadmium,	EC 231-152-8, CAS 7440-43-9
Lead,	EC 231-100-4, CAS 7439-92-1
Phenol, 4-nonyl-, branched,	EC 284-325-5, CAS 84852-15-3

in more than 0,1% w/w in homogeneous material. These substances are included in the "Candidate List of Substances of Very High Concern for Authorisation" of REACH.

Your particular product may contain one or more of the listed substances.

Instructions for safe use:

- use according to Manufacturer instructions, wash hands after use;
- keep out of reach of children, do not put in mouth,
- dispose in accordance with local regulations.

Authorized Service Shops Location

09/16

- The purchaser must contact a Lincoln Authorized Service Facility (LASF) about any defect claimed under Lincoln's warranty period.
- Contact your local Lincoln Sales Representative for assistance in locating a LASF or go to www.lincolnelectric.com/en-gb/Support/Locator.

Electrical Schematic

Refer to the "Spare Part" manual supplied with the machine.

Suggested Accessories

KIT-200A-25-3M	Cable Kit 200A - 25 mm ² - 3m
KIT-200A-35-5M	Cable Kit 200A -35mm ² -5m
KIT-250A-35-5M	Cable Kit 250A -35mm ² -5m
GRD-200A-35-zM	Ground cable 200A -35mm ² z = 5 or 10m
K10513-17-z	TIG torch LT 17 G -140A z = 4m or 8m Ergo
K10529-17-z	TIG torch LTP 17 G -140A z = 4m or 8m Ergo
K10529-17-8F	TIG torch LTP 17 G -140A 8m Lever (French)
K10529-17-4VS	TIG torch LTP 17 G -140A 4m Valve Conn 10-25
K10529-17-zV	TIG torch LTP 17 G -140A z = 4m or 8m Valve Conn 35-50
K10513-9-z	TIG torch LT 9 G -110A z = 4m or 8m Ergo
K10513-26-z	TIG torch LT 26 G -180A z = 4m or 8m Ergo
K10529-26-z	TIG torch LTP 26 G -180A z = 4m, 8m or 12m Ergo
K10529-26-zX	TIG torch LTP 26 G Flex Neck -180A z = 4m or 8m Ergo
K10529-26-8F	TIG torch LTP 26 G -180A 8m Lever (French)
K10529-26-zV	TIG torch LTP 26 GV – 180A z = 4m or 8m Valve Conn 35-50
KP10529-1	Switch module 1-button + 10K Poti Module + 6 Pins plug for LTP torches
KP10529-2	Switch module 1-button for LTP torches
KP10529-3	Switch module 3-button for LTP torches
K14147-1	Remote control - 15 m
K14148-1	Extension cord 15m (*)
K870	Foot Amptrol.

(*) Only 2 Extension Cord for a maximum total length of 45m can be used.