

TOMAHAWK® 1025 & 1538

Spare Parts.....	1
Figure A: Machine Assembly.....	2
Figure B: Machine Assembly.....	4
Electrical Schematic.....	5
CODE: 52095.....	5
CODE: 52076.....	6
LC65, LC65M, LC105 & LC105M.....	7
LC65.....	7
LC65M, LC65M GEAR RACK.....	8
LC105.....	9
LC105M, LC105M GEAR RACK.....	10
LC65 & LC105 Circle Kit (optional).....	11
Torches Dimensions.....	12



Spare Parts

SP52076/52095 REV05
11/22

ASSEMBLY PAGE NAME			Machine Assembly Tomahawk® 1025	Machine Assembly Tomahawk® 1538				
CODE NO.:	K NO.:	FIGURE NO.:	A	B				
52095	K12048-1	TOMAHAWK® 1025	1	-				
52076	K12039-1	TOMAHAWK® 1538	-	1				

*items highlighted in bold are recommended spare parts

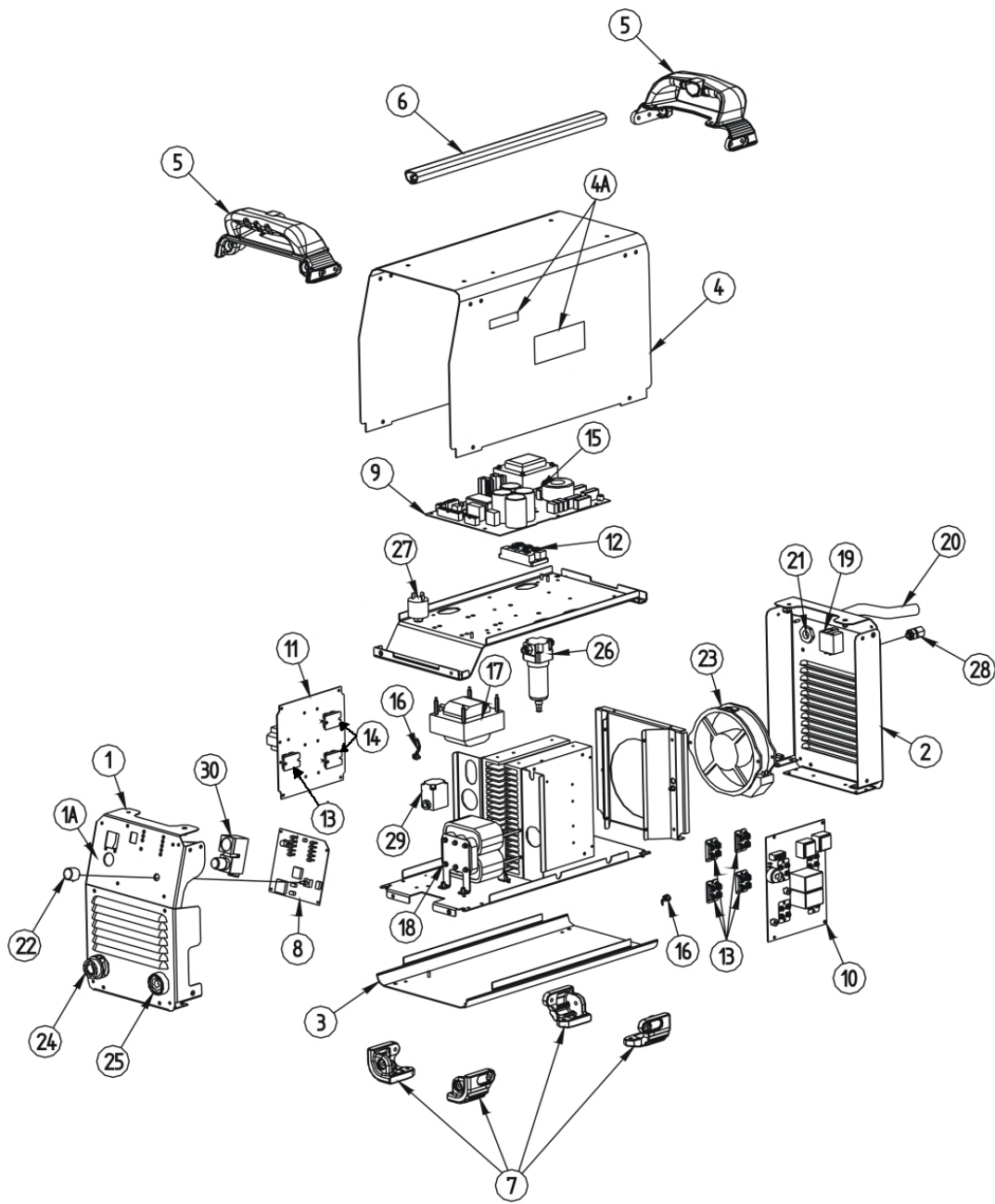

Figure A

Figure A: Machine Assembly

Item	Description	Part Number	QTY	1	2	3	4	5	6	7
1	FRONT FRAME	W93X1165R	1	X						
1A	+ FRONT NAMEPLATE	+ W07X0917R	1	X						
2	REAR FRAME	W93X1166R	1	X						
3	BOTTOM FRAME	W93X1134R	1	X						
4	WRAPAROUND	W93X1133R	1	X						
4A	+ KIT SIDE NAMEPLATES TOMAHAWK	+ W07X1117R	2	X						
5	FRONT / REAR HANDLE	W95X1146R	2	X						
6	CENTRAL HANDLE	W92X0228-5R	1	X						
7	KIT 4 ANTI-SLIP FOOT	W95X1147R	1	X						
8	CONTROL P.C. BOARD	W05X0859R	1	X						
9	INPUT P.C. BOARD	W05X0855-1R	1	X						
10	INVERTER P.C. BOARD WITH IGBTs	W05X0857-1R	1	X						
11	OUTPUT P.C. BOARD WITH DIODEs AND IGBT	W05X0858-1R	1	X						
12	POWER INPUT BRIDGE	W4100012R	1	X						
13	POWER IGBTs	W4300070R	5	X						
14	POWER DIODEs	W4060100R	2	X						
15	AUXILIARY FUSE	W7300500R	1	X						
16	THERMOSTAT SENSOR	W9600071R	2	X						
17	OUT INDUCTOR	W58X0872R	1	X						
18	OUT TRANSFORMER	W59X0871R	1	X						
19	SWITCH	W7500203R	1	X						
20	INPUT CORD	W78X0952R	1	X						
21	CABLE CLAMP	W8400006R	1	X						
22	KNOB	W8700030R	1	X						
23	FAN	W7200007R	1	X						
24	TORCH SHROUD	W03X0935R	1	X						
25	DINSE CONNECTOR	W7600025R	1	X						
26	AIR FILTER	W8800200R	1	X						
27	PRESSURE SWITCH	W8800019R	1	X						
28	AIR INLET PASS-THROUGH	W8800215R	1	X						
29	SOLENOID VALVE	W8800202R	1	X						
30	PRESSURE GAUGE WITH PRESSURE REGULATOR	W8800203R	1	X						

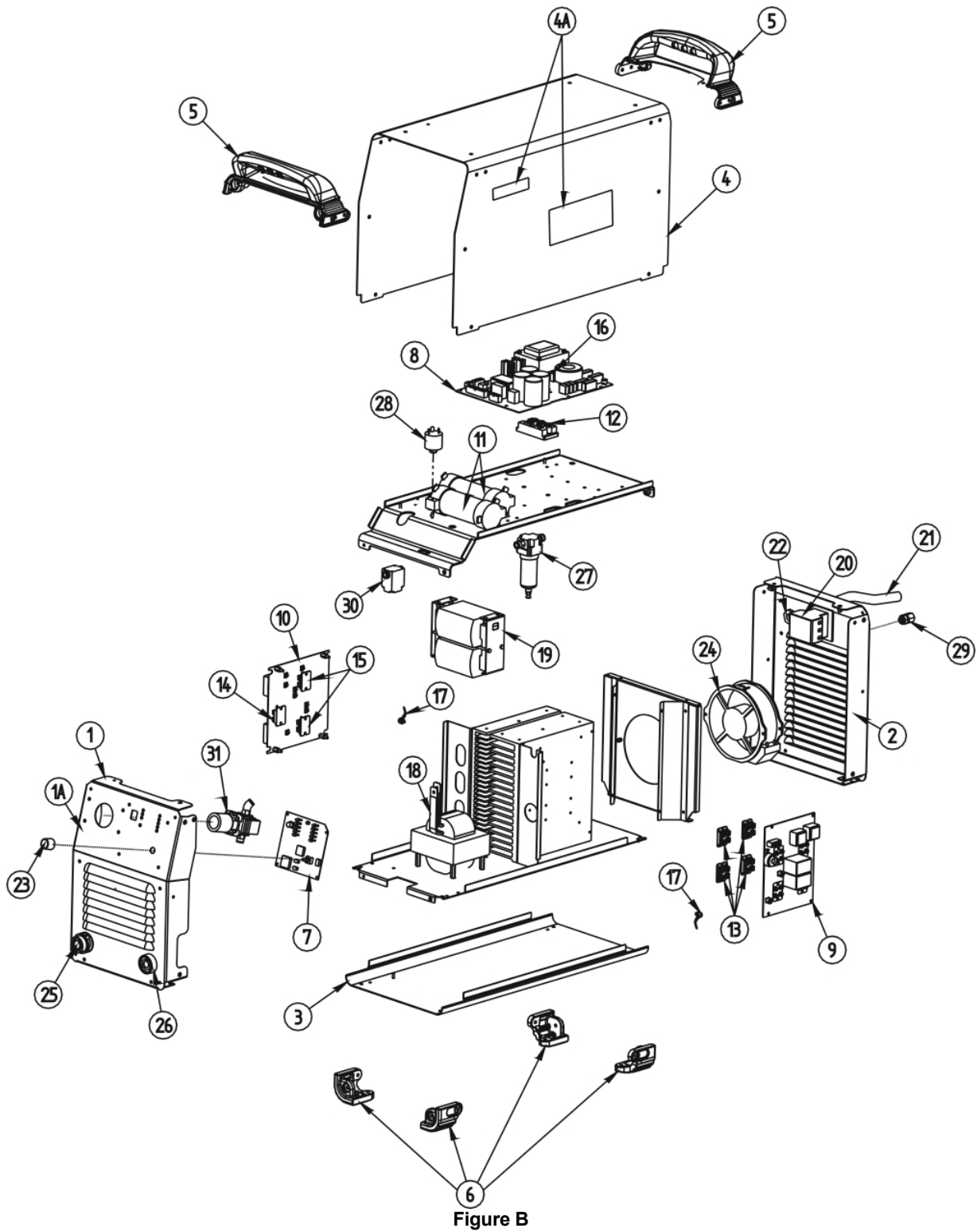

Figure B

Figure B: Machine Assembly

Item	Description	Part Number	QTY	1	2	3	4	5	6	7
1	FRONT FRAME	W93X1151R	1	X						
1A	+ FRONT NAMEPLATE	+ W07X1053R	1	X						
2	REAR FRAME	W93X1152R	1	X						
3	BOTTOM FRAME	W93X1142R	1	X						
4	WRAPAROUND	W93X1141R	1	X						
4A	+ KIT SIDE NAMEPLATES TOMAHAWK	+ W07X1117R	1	X						
5	FRONT / REAR HANDLE	W95X1150R	2	X						
6	KIT 4 ANTI-SLIP FOOT	W95X1147R	1	X						
7	CONTROL P.C. BOARD	W05X0859R	1	X						
8	INPUT P.C. BOARD	W05X0855-2R	1	X						
9	INVERTER P.C. BOARD WITH IGBTs	W05X0857-2R	1	X						
10	OUTPUT P.C. BOARD WITH DIODEs AND IGBT	W05X0858-2R	1	X						
11	D.C. BUS SCREW CAPACITOR	W3488222R	2	X						
12	POWER INPUT BRIDGE	W4100012R	1	X						
13	POWER IGBTs	W4300079R	4	X						
14	POWER STATIC SWITCH IGBTs	W4300070R	1	X						
15	POWER DIODEs	W4010010R	2	X						
16	AUXILIARY FUSE	W7300500R	1	X						
17	THERMOSTAT SENSOR	W9600070R	2	X						
18	OUT INDUCTOR	W58X1005R	1	X						
19	OUT TRANSFORMER	W59X1006R	1	X						
20	SWITCH	W7511706R	1	X						
21	INPUT CORD	W78X0940R	1	X						
22	CABLE CLAMP	W8403222R	1	X						
23	KNOB	W8700030R	1	X						
24	FAN	W7200006R	1	X						
25	TORCH SHROUD	W03X0935R	1	X						
26	DINSE CONNECTOR	W7600025R	1	X						
27	AIR FILTER	W8800200R	1	X						
28	PRESSURE SWITCH	W8800019R	1	X						
29	AIR INLET PASS-THROUGH	W8800315R	1	X						
30	SOLENOID VALVE	W8800302R	1	X						
31	PRESSURE GAUGE WITH PRESSURE REGULATOR	W8800303R	1	X						

Electrical Schematic

CODE: 52095

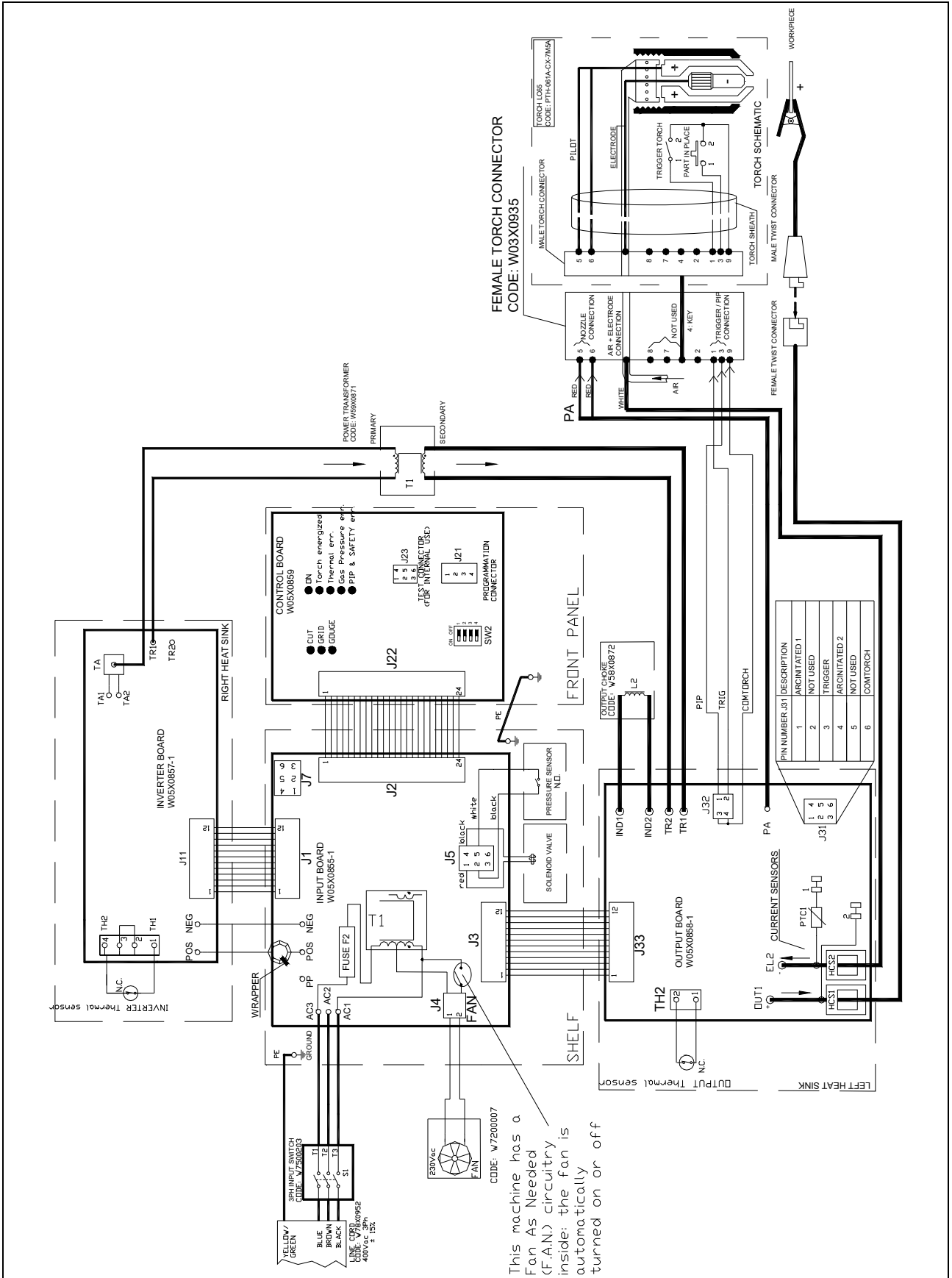

This machine has a Fan As Needed (F.A.N.) circuitry inside; the fan is automatically turned on or off

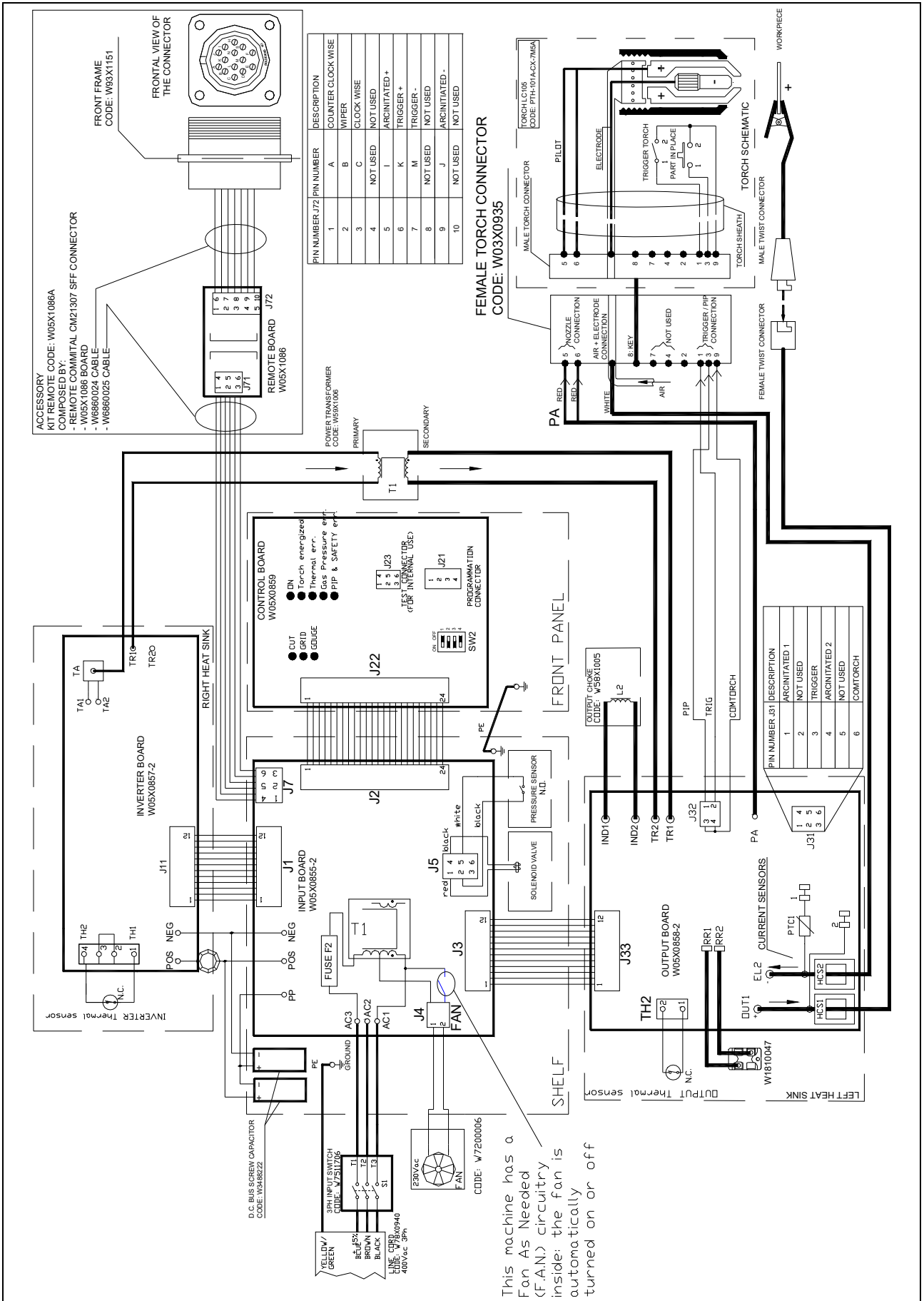







LC65, LC65M, LC105 & LC105M

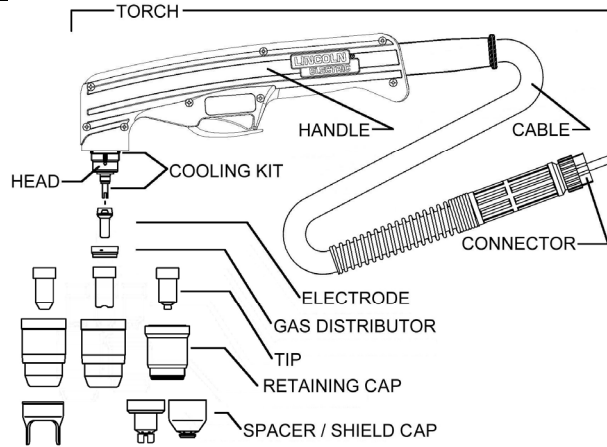



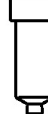

LC65

Torch (Hand 7.5m) (1pc)	PTH-061A-CX-7M5A
Torch (Hand 15m) (1pc)	PTH-061A-CX-15MA
Handle (1pc)	W0300609R
Head (1pc)	W0300608R

Cooling Kit (blister 1pc)	W03X0893-49R
Cable (7.5m) (1pc)	W0300604R
Cable (15m) (1pc)	W0300606R
Connector (1pc)	W03X0934-4R



Cutting process	Electrode (blister 5pcs)		Gas Distr. (blister 3pcs)	Tip (blister 5pcs)			
							
40A	W03X0893-25A		W03X0893-50R	W03X0893-27A			
50A	W03X0893-25A		W03X0893-50R	W03X0893-28A			
60A	W03X0893-25A		W03X0893-50R	W03X0893-29A			
Dir Contact 40A	W03X0893-25A		W03X0893-50R		W03X0893-26A		
Contact 50A	W03X0893-25A		W03X0893-50R			W03X0893-33A	
Contact 60A	W03X0893-25A		W03X0893-50R			W03X0893-34A	
Ext Contact 40A		W03X0893-53A	W03X0893-50R				W03X0893-40A
Ext Contact 60A		W03X0893-53A	W03X0893-50R				W03X0893-54A
Gouging	W03X0893-25A		W03X0893-50R			W03X0893-39A	

Cutting process	Retaining Cap (blister 1pc)		Spacer (blister 2pcs)	Shield Cap (blister 2pcs)		
						
40A	W03X0893-41A		W03X0893-14R			
50A	W03X0893-41A		W03X0893-14R			
60A	W03X0893-41A		W03X0893-14R			
Dir Contact 40A	W03X0893-41A					
Contact 50A		W03X0893-43A		W03X0893-44A		
Contact 60A		W03X0893-43A		W03X0893-44A		
Ext Contact 40A		W03X0893-43A			W03X0893-21A	
Ext Contact 60A		W03X0893-43A			W03X0893-21A	
Gouging		W03X0893-43A				W03X0893-48A



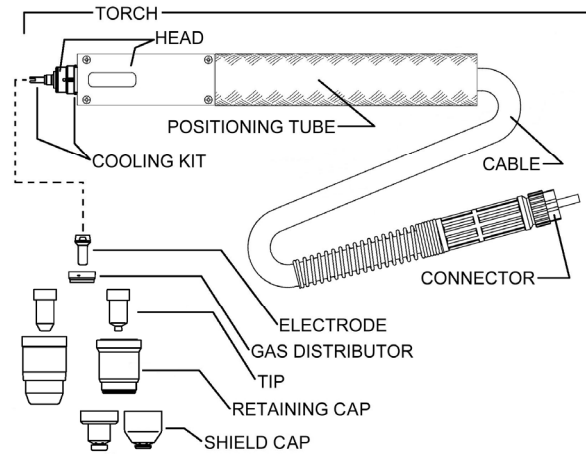

LC65M, LC65M GEAR RACK

	LC65M	LC65M GEAR RACK
Torch (Machine 7.5m) (1pc)	PTM-061A-CX-7M5A	PTR-061A-CX-7M5A
Torch (Machine 15m) (1pc)	PTM-061A-CX-15MA	PTR-061A-CX-15MA
Positioning tube (1pc)	W0300603R	W0300624R

Head (1pc)	W0300610R
Cooling Kit (blister 1pc)	W03X0893-49R
Cable (7.5m) (1pc)	W0300605R
Cable (15m) (1pc)	W0300607R
Connector (1pc)	W03X0934-4R



Cutting process	Electrode (blister 5pcs)	Gas Distr. (blister 3pcs)	Tip (blister 5pcs)	
				
40A	W03X0893-25A	W03X0893-50R	W03X0893-27A	
50A	W03X0893-25A	W03X0893-50R	W03X0893-28A	
60A	W03X0893-25A	W03X0893-50R	W03X0893-29A	
Shielded 40A	W03X0893-25A	W03X0893-50R		W03X0893-52A
Shielded 50A	W03X0893-25A	W03X0893-50R		W03X0893-33A
Shielded 60A	W03X0893-25A	W03X0893-50R		W03X0893-34A
Gouging	W03X0893-25A	W03X0893-50R		W03X0893-39A

Cutting process	Retaining Cap (blister 1pc)	Shield Cap (blister 2pcs)	
	 		
40A	W03X0893-41A		
50A	W03X0893-41A		
60A	W03X0893-41A		
Shielded 40A		W03X0893-43A	W03X0893-46A
Shielded 50A		W03X0893-43A	W03X0893-46A
Shielded 60A		W03X0893-43A	W03X0893-46A
Gouging		W03X0893-43A	W03X0893-48A

LC105

Torch (Hand 7.5m) (1pc)	PTH-101A-CX-7M5A
Torch (Hand 15m) (1pc)	PTH-101A-CX-15MA
Handle (1pc)	W0300609R
Head (1pc)	W0300618R

Insulation Kit (blister 1pc)	W03X0893-71R
Cable (7.5m) (1pc)	W0300620R
Cable (15m) (1pc)	W0300621R
Connector (1pc)	W03X0934-8R

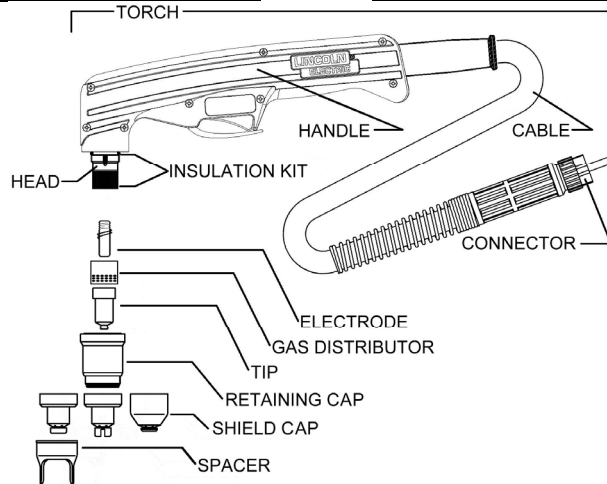

	Electrode (blister 5pcs)	Gas Distr. (blister 2pcs)	Tip (blister 5pcs)	
Cutting process				
40A	W03X0893-60A	W03X0893-70R	W03X0893-61A	
60A	W03X0893-60A	W03X0893-70R	W03X0893-62A	
80A	W03X0893-60A	W03X0893-70R	W03X0893-63A	
100A	W03X0893-60A	W03X0893-70R	W03X0893-64A	
Contact 40A	W03X0893-60A	W03X0893-70R	W03X0893-61A	
Contact 60A	W03X0893-60A	W03X0893-70R	W03X0893-62A	
Contact 80A	W03X0893-60A	W03X0893-70R	W03X0893-63A	
Contact 100A	W03X0893-60A	W03X0893-70R	W03X0893-64A	
Ext Contact 40A	W03X0893-57A	W03X0893-70R		W03X0893-58A
Ext Contact 60A	W03X0893-57A	W03X0893-70R		W03X0893-59A
Ext Contact 80A	W03X0893-57A	W03X0893-70R		W03X0893-72A
Ext Contact 100A	W03X0893-57A	W03X0893-70R		W03X0893-73A
Gouging	W03X0893-60A	W03X0893-70R	W03X0893-65A	



	Retaining Cap (blister 1pc)	Spacer (blister 2pcs)	Shield Cap (blister 2pcs)		
Cutting process					
40A	W03X0893-66A	W03X0893-14R	W03X0893-68A		
60A	W03X0893-66A	W03X0893-14R	W03X0893-68A		
80A	W03X0893-66A	W03X0893-14R	W03X0893-68A		
100A	W03X0893-66A	W03X0893-14R	W03X0893-68A		
Contact 40A	W03X0893-66A			W03X0893-67A	
Contact 60A	W03X0893-66A			W03X0893-67A	
Contact 80A	W03X0893-66A			W03X0893-67A	
Contact 100A	W03X0893-66A			W03X0893-67A	
Ext Contact 40A	W03X0893-66A				W03X0893-74A
Ext Contact 60A	W03X0893-66A				W03X0893-74A
Ext Contact 80A	W03X0893-66A				W03X0893-74A
Ext Contact 100A	W03X0893-66A				W03X0893-74A
Gouging	W03X0893-66A				W03X0893-69A

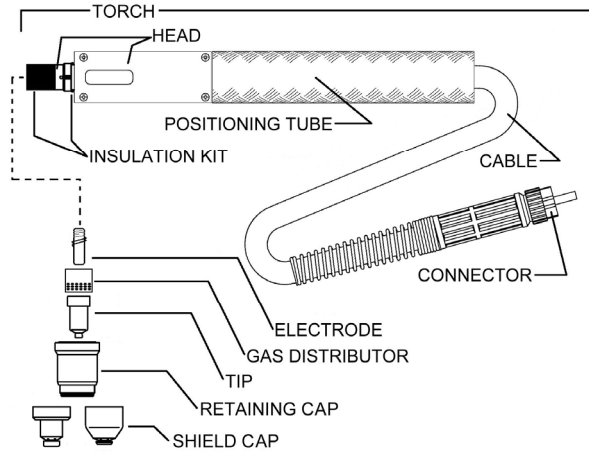

LC105M, LC105M GEAR RACK

	LC105M	LC105M GEAR RACK
Torch (Machine 7.5m) (1pc)	PTM-101A-CX-7M5A	PTR-101A-CX-7M5A
Torch (Machine 15m) (1pc)	PTM-101A-CX-15MA	PTR-101A-CX-15MA
Positioning tube (1pc)	W0300603R	W0300624R

Head (1pc)	W0300619R
Insulation Kit (blister 1pc)	W03X0893-71R
Cable (7.5m) (1pc)	W0300622R
Cable (15m) (1pc)	W0300623R
Connector (1pc)	W03X0934-8R



	Electrode (blister 5pcs)	Gas Distr. (blister 2pcs)	Tip (blister 5pcs)
Cutting process			
40A	W03X0893-60A	W03X0893-70R	W03X0893-61A
60A	W03X0893-60A	W03X0893-70R	W03X0893-62A
80A	W03X0893-60A	W03X0893-70R	W03X0893-63A
100A	W03X0893-60A	W03X0893-70R	W03X0893-64A
Gouging	W03X0893-60A	W03X0893-70R	W03X0893-65A

	Retaining Cap (blister 1pc)	Shield Cap (blister 2pcs)
Cutting process		 
40A	W03X0893-66A	W03X0893-68A
60A	W03X0893-66A	W03X0893-68A
80A	W03X0893-66A	W03X0893-68A
100A	W03X0893-66A	W03X0893-68A
Gouging	W03X0893-66A	W03X0893-69A

LC65 & LC105 Circle Kit (optional)

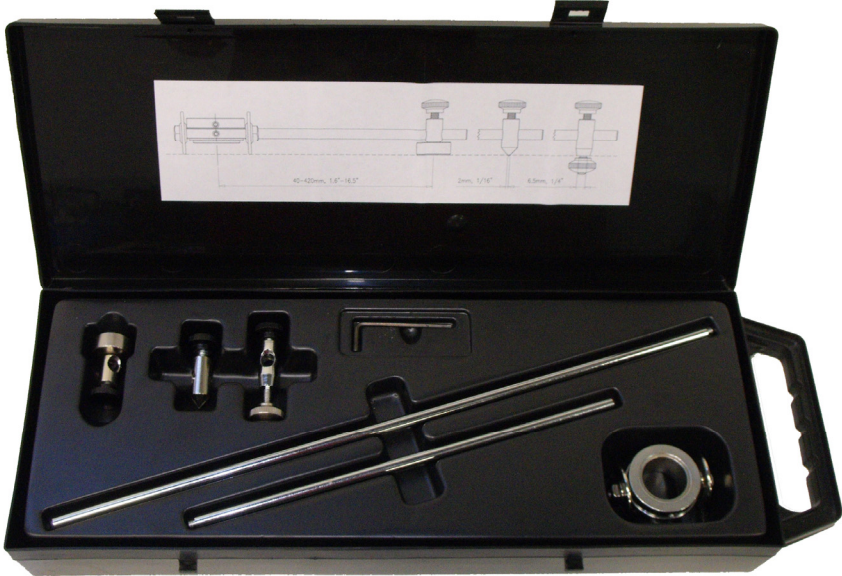

W0300699A LC Circle Kit (optional)

Torches Dimensions

